



NeosGPS

Operation Manual



Table of Contents

Getting Started.....	3	Smart Notifications	16
NeosGPS Button		Appendix.....	17
Introduction.....	3	Specifications	17
Restart NeosGPS.....	3	Install NeosGPS.....	18
Accessories	4	Install Smart Speed/Cadence	
Status Icon	4	Sensor (optional).....	19
Step 1: Charging your		Install Smart Heart Rate Monitor	
NeosGPS.....	5	Belt (optional)	20
Step 2: Turn On NeosGPS.....	5	Wheel Diameter and	
Step 3: Initial Settings.....	5	Circumference.....	21
Step 4: Connecting to		NeosGPS Basic Maintenance	22
Satellite Signal	6	Digital Information.....	23
Step 5: Start Riding With		Declaration of the Presence	
NeosGPS.....	6	Condition of the Restricted	
Step 6: Share Your Records	6	Substances Marking	24
Sync Records to the Giant			
NeosTrack App.....	7		
Setup	10		
Units of Measurement.....	10		
Time Display	10		
Altitude Calibration.....	11		
Start Biking	11		
Enable GPS.....	12		
Sensor Pairing	12		
Delete Records.....	13		
Adjust Odometer	13		
Giant NeosTrack App			
Advanced Settings.....	14		
Stopwatch Information	14		
Altitude Calibration.....	15		

Warning

Consult your physician before starting any training.

Please read the "Warranty and Safety Information" guidelines included with your product.

Getting Started

This section explains the basic setup procedure before using your NeosGPS.

NeosGPS Button Introduction



A Power/OK ()

- Press to turn on the device.
- Press and hold to turn the device off.
- Press to enter/leave the "Menu" page.

C Change Page ()

- Press this button to start recording in the free biking mode.
- Press to stop recording when in the exercise data logging mode.
- Press DOWN key to enter or validate options in the "Menu" page.

B Backlight/Page ()

- Press and hold to turn the backlight on/off.
- Press DOWN key to scroll down the menu options in the "Menu" page.
- Press DOWN key to switch in between the stopwatch pages in the "Stopwatch" mode.
- Page Up/Down: Press to view biking pages in the information mode.

Restart NeosGPS

Press and hold the () keys to restart NeosGPS.

Accessories



























NeosGPS comes with the following accessories:

- USB charging cable
- Bicycle mount





Optional accessories include:

- GIANT HEART RATE SENSOR(410000075)
- RideSync/Garmin & Gopro Mount for 31.8mm Round Bars (410000072)
- RideSync/Garmin & Gopro Mount for Contact SLR Aero Handlebars (410000073)

Status Icon

Icon	Instructions	Icon	Instructions	Icon	Instructions
Bike in Use Now		Setup		Accessory Pairing	
	Bike 1		Daylight Saving Time		Heart Rate Sensor Paired
	Bike 2		Backlight		Speed Sensor Paired
GPS Signal Status		AM PM	AM PM		Cadence Sensor Paired
	No Signal (not positioned)		Choose 12 or 24 Hour Clock		Riding Data Recording
	Poor Signal	Stopwatch Information			Bluetooth Connected
	Good Signal		Slope		
Battery Charge Status			Total Ascending Height		
	Fully Charged		Total Descending Height		
	Battery Charge OK		Ride Time		
	Battery Charge Low		Trip Time		
Smart Notifications			Odometer		
	Text Notification		Maximum Value		
	Call Notification		Average Value		
	E-mail Notification				

Note:

- Accessory icons will display on the status bar when paired.
- When the device battery is low the battery symbol () will begin to flash.
- When the smart sensor is out of the connection range, the sensor symbol (  ) will begin to flash.

Step 1: Charging your NeosGPS

Remove the USB cable from the packaging and connect your NeosGPS to your computer for auto charging. Please charge it for at least 4 hours. Remove the USB cable once it is fully charged.

- When the battery is low, the battery icon will flash; please connect it to a power source until it is fully charged.
- Charge your battery in a temperature range of 0°C-40°C (32°F - 105°F) or the charging will stop and the device will consume battery power.

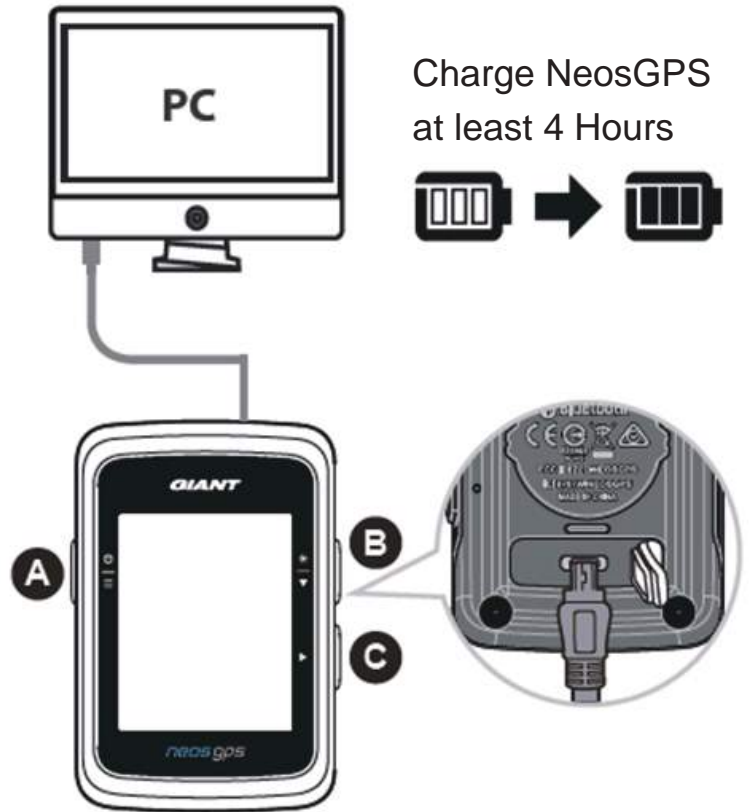

Step 2: Turn On NeosGPS

Press the  button to power on your device.

Step 3: Initial Settings

Installation steps display in your first NeosGPS installation. Please follow the steps below to complete the setup. (Please refer to page 10 for detailed settings)

1. Press  to choose measurement units.







Step 4: Connecting to Satellite Signal

Once the NeosGPS is powered on it will start searching for satellite signals automatically. It may take 30 to 60 seconds to receive satellite signals. Please acquire GPS positioning before using it for the first time.

The GPS signal icon () will display after the GPS is positioned successfully.

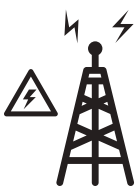
- If GPS positioning fails, the  icon will display.
- DO NOT search for a GPS signal in the following environment as the latter may interfere with signal reception.

				
In Tunnels	Indoor/Within building/ Underground	Underwater	High Voltage Cables or TV Tower	Construction Site or in Traffic Jams

Step 5: Start Riding With NeosGPS

- Easy Ride:
NeosGPS will detect the motion of your bike starting and stopping automatically.
- Start Riding and Record Data:
Press ▶ to start recording and press ▶ again to stop.

Step 6: Share Your Records

Share Your Records to the NeosTrack website

1. Register or log in.
 - a. Visit <https://www.NeosTrack.com>.
 - b. Register a new account.
2. Connect the device to a computer.
Power on the NeosGPS and connect it to your computer with a USB cable.
3. Share your records.
 - a. Click the "+" symbol in the upper right corner to add new activity entries.
 - b. Drag and drop FIT, BDX, or GPX files or click "Select file" to upload.
 - c. Click "Activity Log" to view just uploaded records.

Share Your Records to Strava.com

1. Register or log in to Strava.com.
 - a. Visit <https://www.strava.com>.
 - b. Register a new account or log in with your active Strava account.
2. Connect the device to a computer.

Power on the NeosGPS and connect it to your computer with a USB cable.
3. Share your records.
 - a. Click the "+" symbol in the upper right corner and click "File".
 - b. Click "Select File", then select the desired FIT files from the GIANT folder to upload them.
 - c. Input relevant riding information, click the "Save and View" key to upload them.

Sync Records to the Giant NeosTrack App

Start Using the Giant Mobile App

1. Download the Giant Mobile App.





Scan the QR Code at the bottom of the page to download the Giant NeosTrack APP or search for and download it in the Google Play/App Store.
2. Register with the Giant NeosTrack APP.
 - a. Open the Giant NeosTrack APP.
 - b. Register a new account.

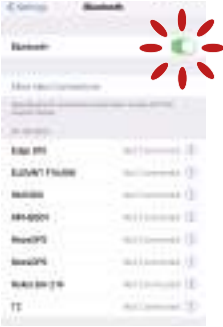

Note: Sync the Giant NeosTrack APP with NeosTrack.com. Please log in NeosTrack.com with your existing account, otherwise create a new one.

Bluetooth Pairing With the Giant NeosTrack App

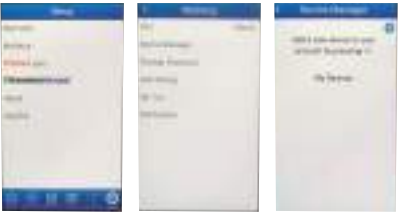
NeosGPS can sync wirelessly with a Bluetooth connection. Please pair NeosGPS with the NeosTrack App before any sync to enable correct records synchronization.

<p>a. Enable the "Bluetooth" function of your cell phone.</p> 	<p>b. Press the Power key to enable NeosGPS.</p> 	<p>c. Click "Bluetooth Sync" to maintain the networking function.</p> 
<p>d. Select MySetup > Device Manager >and Press the "+" key.</p> 	<p>e. Select Bluetooth 4.0.</p> 	<p>f-1. Select the NeosGPS for pairing +. f-2. Press "OK". f-3. Your device has successfully paired with the Giant NeosTrack App, tap to complete.</p> 
<p>g. Start uploading records from the paired device.</p> 	<p>h. All records uploaded.</p> 	<p>i. Go to the "Activity Log" to see uploaded records.</p> 

One-click Record Upload

After the device is successfully paired with the Giant NeosTrack App and the Bluetooth connection

remains active, you may click  to auto upload all records to the Giant NeosTrack App.

Bluetooth Sync

Software Updates

Note: NeosGPS software features regular updates for quicker GPS positioning and optimization. It is recommended that you check for new updates every two to four weeks.

1. Check this website to see if there is a newer version.
www.giant-bicycles.com/download
2. Connect to the USB port of a computer, save files in NeosGPS folder.
3. Unplug the USB cable once the operation is completed and the NeosGPS will start updating automatically.

Identify Whether Your NeosGPS is the Latest Version

1. Connect the NeosGPS to computer with a USB cable.
2. Click System -> Device to view the edition of the current model and release.

Setup

You may customize the following functions with the "Setup" function: unit of measure, daylight saving time, current altitude, bike, wheel diameter, sensor pairing and odometer.

Unit of Measure

You may choose KM/H or MI/H for UOM display.



1. Press ☉ to enter the UNIT setup page.
2. Press \blacktriangleright -> and $\star\blacktriangledown$
3. Press \blacktriangleright to validate the selection made.
4. Press ☉ to exit setup.

Time Display

You may select 12 or 24 hour time format and set up daylight saving time here.



1. Press ☉ to enter the setup page.
2. Press $\star\blacktriangledown$ to select HOUR, press \blacktriangleright and the HOUR setup page will display.
3. Press $\star\blacktriangledown$ to select 12h or 24h, press \blacktriangleright to validate the selection made.
4. The daylight saving time page of the NeosGPS display, press $\star\blacktriangledown$ to select the desired number, press \blacktriangleright to validate the selection made and proceed to the next one. Repeat the above steps to complete the setting. Press ☉ to return to the main setup page if no changes are required and press again to exit.



$\star\blacktriangledown$ Select Number





- or 0	00:00
1 or 2	00:00
00 or 30	00:00

5. Once all settings have been made, press \blacktriangleright to validate the selections made and exit back to the main setup page and press ☉ to exit.



Altitude Calibration

You may calibrate the current altitude.

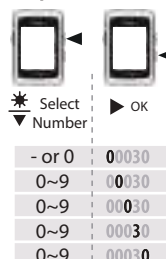

1. Press  to enter the setup page.
2. Press  to select ALT, press  and the ALT setup page will display.
3. Press  to select the desired number, press  to validate the selection made and proceed to the next one. Repeat the above steps to complete the setting.











4. Once all settings have been made, press  to validate the selections made and press  to exit.

Note: Once the current altitude value in Settings is changed its counterpart in the stopwatch mode will change accordingly.



Start Biking

You may select bikes to enable and modify wheel diameter.

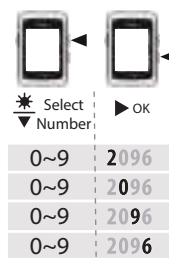

1. Press  to enter the setup page.
2. Press  to select BIKE, press  and the BIKE setup page will display.
3. Press  to select BIKE1 or BIKE2, press  to validate the selection made.
4. The wheel diameter page of the NeosGPS will display, press  to select the desired number, press  to validate the selection made and proceed to the next one. Repeat the above steps to complete the setting. Press  to return to the main setup page if no changes are required and press again to exit.









5. Once all settings have been made, press  to validate the selections made and exit back to the main setup page and press  to exit.

Note: Please refer to "Wheel Diameter and Circumference" on page 24 for details on wheel dimension.

Enable GPS

Please disable GPS signaling in the event of indoor exercise to prevent recording less accurate ride information.







1. Press  to enter the setup page.
2. Press  to select GPS, press  and the GPS setup page will display.
3. Press  to select ON or OFF, press  to validate the selection made.
4. Once all settings have been made, press  to validate the selections made and exit back to the main setup page and press  to exit.

Sensor Pairing





NeosGPS supports Bluetooth peripheral sensors. Please follow the steps below to pair.



1. Press  to enter the setup page.
2. Press  to select SYNC, press  and the SYNC setup page will display.
3. Press  to select HR or SP-CA, press  to validate the selection made.
4. Wake up the sensor by putting on the heart rate belt, or pedaling the crank and wheel.

Note: The sensor can be paired only in standby mode; otherwise it will enter sleep mode to conserve battery charge.



5. NeosGPS prompts the message "YES" when it detects the sensor successfully; press  to validate the pairing; press  to select "NO" and  to cancel the pairing and start scanning again.
6. Once all settings have been made, press  to exit the setup page.

Note:

- Keep away from other Bluetooth sensors when pairing.
- After successful pairing, the NeosGPS smart sensor will auto connect to the device once it is awoken.

Delete Records

You may delete all or some records for the device to log at least 8, 16 or 24 hours of riding data.



1. Press to enter the setup page.
2. Press to select DEL, press and the DEL setup page will display.
3. Press to select >8h, >16h, >24h or ALL, press to validate the selection made.
4. Once all settings have been made, press to validate the selections made.
5. Press to exit the setup page.

Note:

- NeosGPS may log up to 120 hours of biking in the smart recording mode and up to 30 hours of biking by entry-per-second mode.
- When you start riding or press to start recording, the number of hours left for recording display in cells at the center of the page.
- Options ">8h", ">16h", and ">24h" work only when the storage space of the device can last less than 8h, 16h, 24h. Select these options to record at least 8h, 16h, and 24h more rather than another 8h, 16h and 24h.

Adjust Odometer

You may adjust odometer.



1. Press to enter the setup page.
2. Press to select ODO, press and the ODO setup page will display.
3. Press to select the desired number, press to validate the selection made and proceed to the next one. Repeat the above steps to complete the setting.

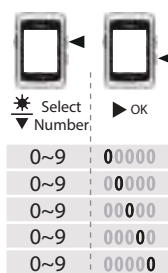

4. Once all settings have been made, press to validate the selections made and exit back to the main setup page and press to exit.

Giant Advanced Settings

After NeosGPS is paired with the Giant NeosTrack App, you can change the stopwatch information and correct the altitude.

Custom Page Information

You may change the stopwatch information page, set up MHR (Max Heart Rate) and LTHR (Lactate Threshold Heart Rate), enable/disable smart pause, and data recording frequency according to your training objectives.

1. Pair NeosGPS With the Giant NeosTrack App
 - a. Open NeosGPS.
 - b. Enable the Bluetooth function of your cell phone.
 - c. In the Giant NeosTrack App, click through Setup > User Setup > Device Management.
 - d. Press the "+" key and select Bluetooth 4.0.
 - e. Select the device you want to pair with then click the "+" key.
 - f. Click "Pair" to pair your device with your phone (for iOS devices only).
 - g. Validate UUID of the paired device and click "Yes".
 - h. Click Finish.
2. Change Your Stopwatch Information Page
 - a. Click Setup > Stopwatch Information in the Giant NeosTrack App.
 - b. Click the "OK" key to enable connection with the device.
 - c. Select the manual mode to adjust the information page.
Select Auto to maintain the factory mode.
 - d. Click "<" or ">" to change the number of information cells.
 - e. Tap 1, 2, 3, 4, or 5 to switch the information page.
 - f. Click the device page information cell to change riding information.
3. Input Your MHR and LTHR
 - a. Click  to enter the setup page.
 - b. Click MHR and LTHR to input your MHR and LTHR value.
4. Enable/Disable Smart Pause
Click the smart pause column to turn it on/off.
5. Set up Data Record
Click the data record column to change to the desired settings.
6. Sync Setup to NeosGPS
Click the "<" in the upper left corner and select "Sync" to apply changed settings to NeosGPS.

Note:

- To reset your stopwatch back to its factory default settings: tap  and tap "Yes" in the "Reset to factory default?" dialog prompt.

Altitude Calibration

When connected to the Internet, the Giant NeosTrack App will provide you with the altitude of your current location so that you can calibrate it automatically or manually.

1. Pair NeosGPS With the Giant NeosTrack App
 - a. Open NeosGPS.
 - b. Enable the Bluetooth function of your cell phone.
 - c. In the Giant NeosTrack App, click through Setup > User Setup > Device Management.
 - d. Press the "+" key and select Bluetooth 4.0.
 - e. Select the device you want to pair with then click the "+" key.
 - f. Click "Pair" to pair your device with your phone (for iOS devices only).
 - g. Validate UUID of the paired device and click "Yes".
 - h. Click Finish.
2. Calibrate Altitude
 - a. Click the "Altitude Calibration" option in the Giant NeosTrack App.
 - b. Click to permit the Giant NeosTrack App to access altitude data contained in the current position.
 - c. The Giant NeosTrack App displays the altitude of your current position. You may change it by pressing  or click the altitude field to input the value.
 - d. Click "Calibration".
 - e. The Giant NeosTrack App begins detecting devices ready for connection. Click OK to connect to your NeosGPS.
 - f. Click "Yes" to validate altitude calibration.
 - g. The calibration completion message appears, click to acknowledge.

POP OUT Notifications

Pair your smart phone with NeosGPS through smart wireless Bluetooth technology to receive notifications of incoming calls, texts and e-mails.

1. Pair With an iOS Cell Phone

- a. Turn on NeosGPS.
- b. Enable the Bluetooth function of your cell phone.
- c. In the Giant NeosTrack App, click through Setup > User Setup > Device Management.
- d. Press the "+" key and select Bluetooth 4.0.
- e. Select the device you want to pair with then click the "+" key.
- f. Click "Pair" to pair your device with your phone.
- g. Validate UUID of the paired device and click "Yes".

Note:

- If no smart notifications appear, go to Settings > Notifications on your phone to check whether you have enabled compatible mailboxes and community apps to show notifications as well as the reminder settings in community apps.
- Press  to clear the smart notification icon.

1. Pair With an Android Cell phone

- a. Open NeosGPS.
- b. Enable the Bluetooth function of your cell phone.
- c. In the Giant NeosTrack App, click through Setup > User Setup > Device Management.
- d. Press the "+" key and select Bluetooth 4.0.
- e. Select the device you want to pair with then click the "+" key.
- f. Validate UUID of the paired device and click "Yes".
- g. Click Finish.

2. Notification Access Permission

- a. Click through Setup > User Setup > Smart Notification.
- b. Click to enable notification access.
- c. Click Giant to permit notification access.
- d. Exit to the Smart Notifications Setup Page.
- e. Select and open individual notifications to complete the setup operation!



Call Notification



E-mail Notification



Text Notification

Appendix

Specifications

NeosGPS

Item	Instructions
Stopwatch Information Display	2" code break HTN LCD
Dimensions	71 x 46.2 x 16.5 mm
Weight	52g
Operating Temperature	-10°C~50°C
Battery Charging Temperature	0°C~40°C
Battery	Lithium battery
Battery Service Time	In open sky for 16 hours
GPS	Integrated high-sensitivity receiver with built-in planar antenna
Smart Bluetooth	Smart wireless Bluetooth technology with built-in planar antenna
Waterproofing	Waterproof for 30 minutes in 1 meter deep water
Pneumatic Altimeter	Built-in pneumatic altimeter

Smart Speed Sensor

Item	Instructions
Dimensions	36.9 x 34.8 x 8.1 mm
Weight	6 g
Waterproofing	Waterproof for 30 minutes in 1 meter deep water
Transmission Scope	3 m
Battery Service Time	It may last 9 months if you use it for one hour each day
Operating Temperature	-10°C~60°C
Radio Frequency/ Communication Protocol	2.4GHz/smart Bluetooth and Dynast ream ANT + Sport wireless communication protocol

Note: Poor sensor contact, electrical and magnetic interference, and long distance between receiver and transmitter may hamper accuracy. Please install sensors on the front wheel in the event of outdoor biking as the rear one usually suffers from a more complex environment; in the event magnetic interference problems persist, try biking in another location, or washing or replacing the chain.

Install NeosGPS

Mount NeosGPS to a Bicycle Mount

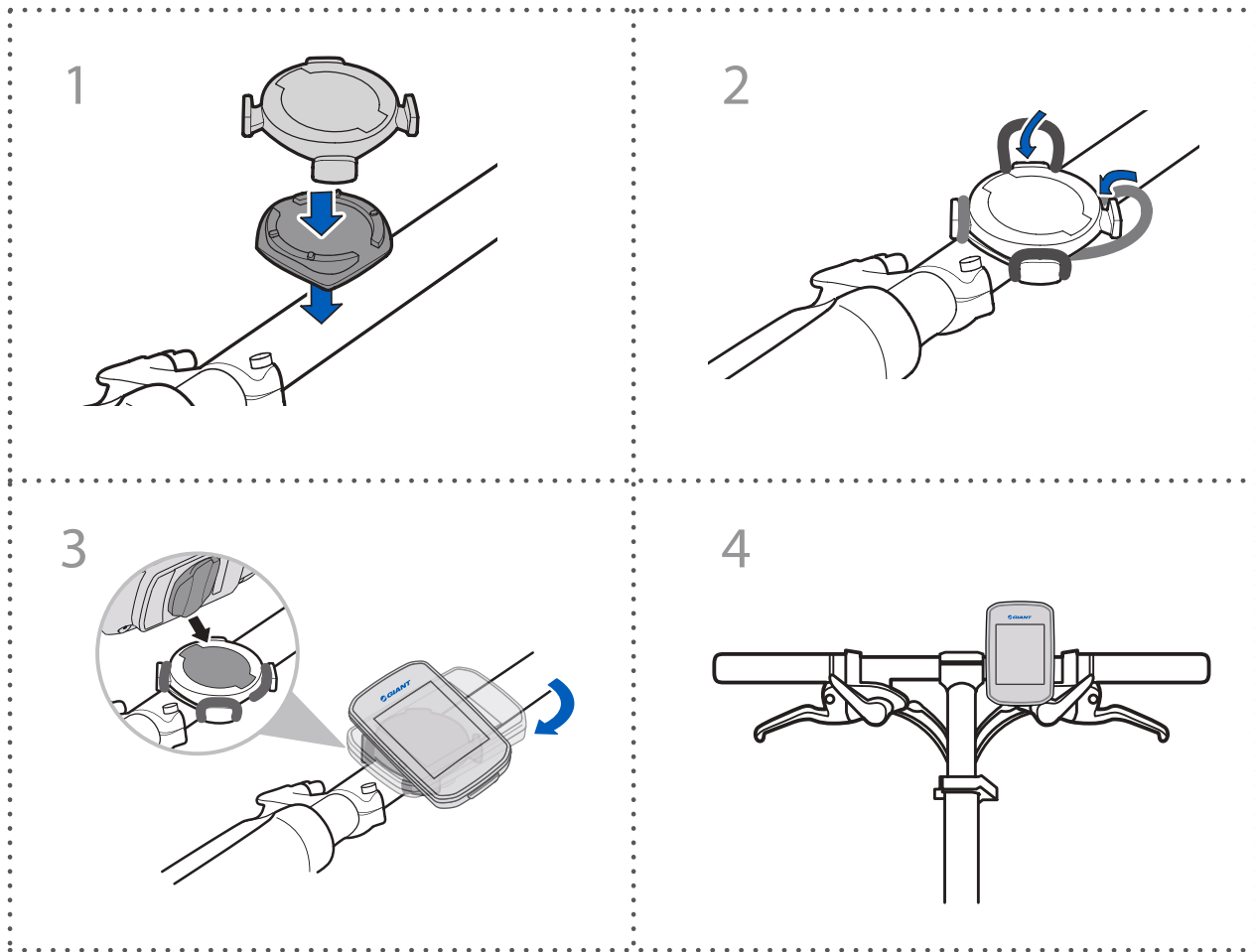

Use a Circular/Flat Tube Headlight Stopwatch Base to Install NeosGPS (optional)

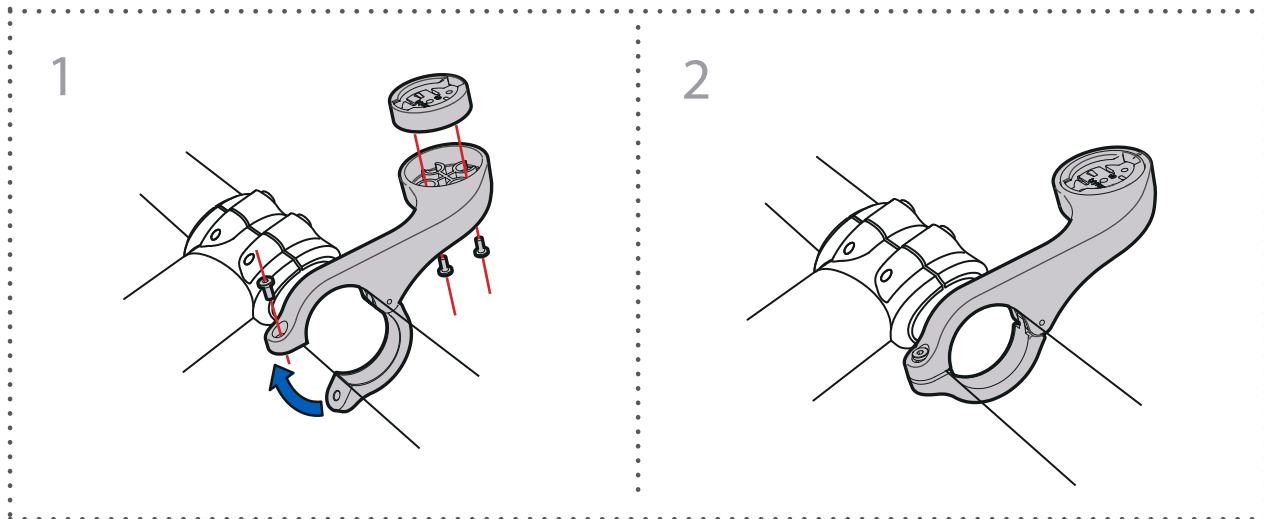

Install Smart Speed/Cadence Sensor (optional)

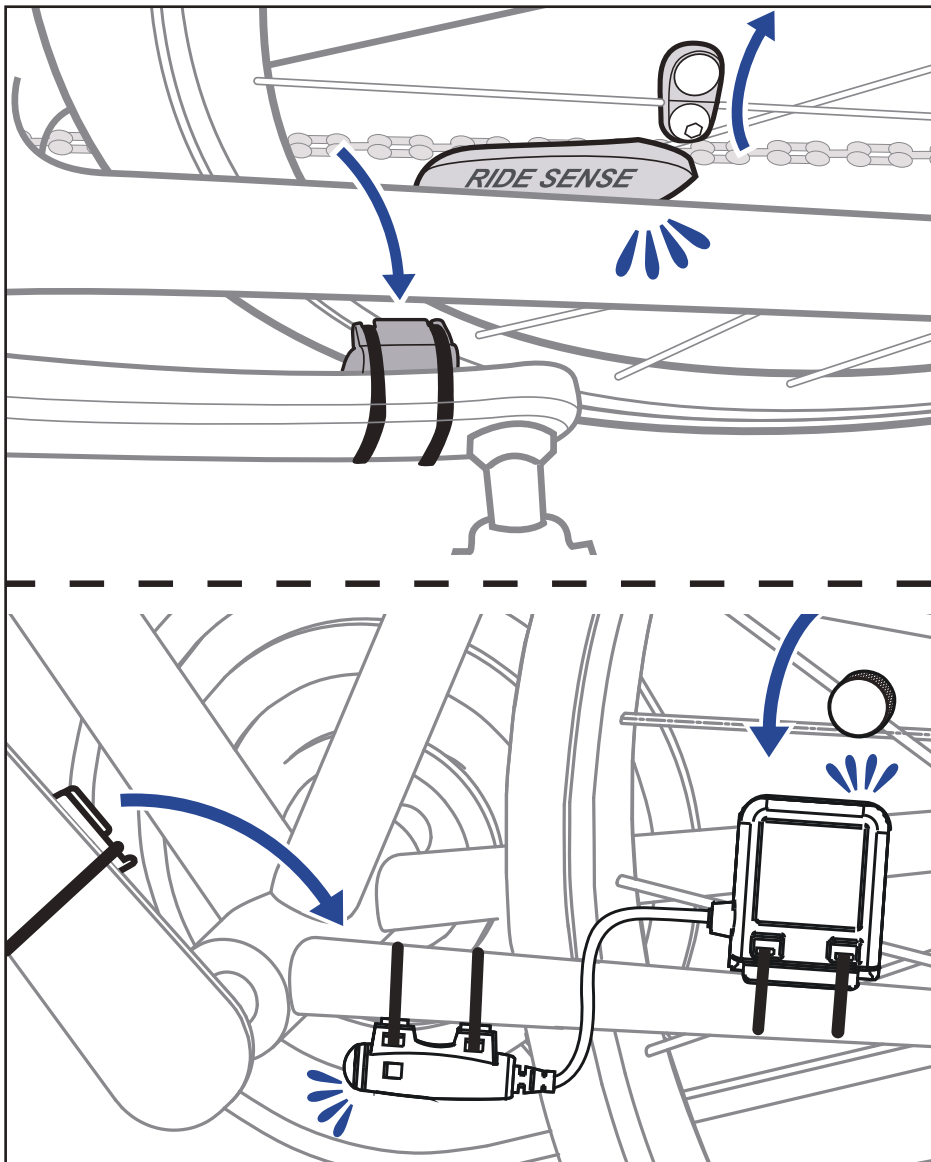

Install the "Smart Heart Rate Monitor Belt" (optional)

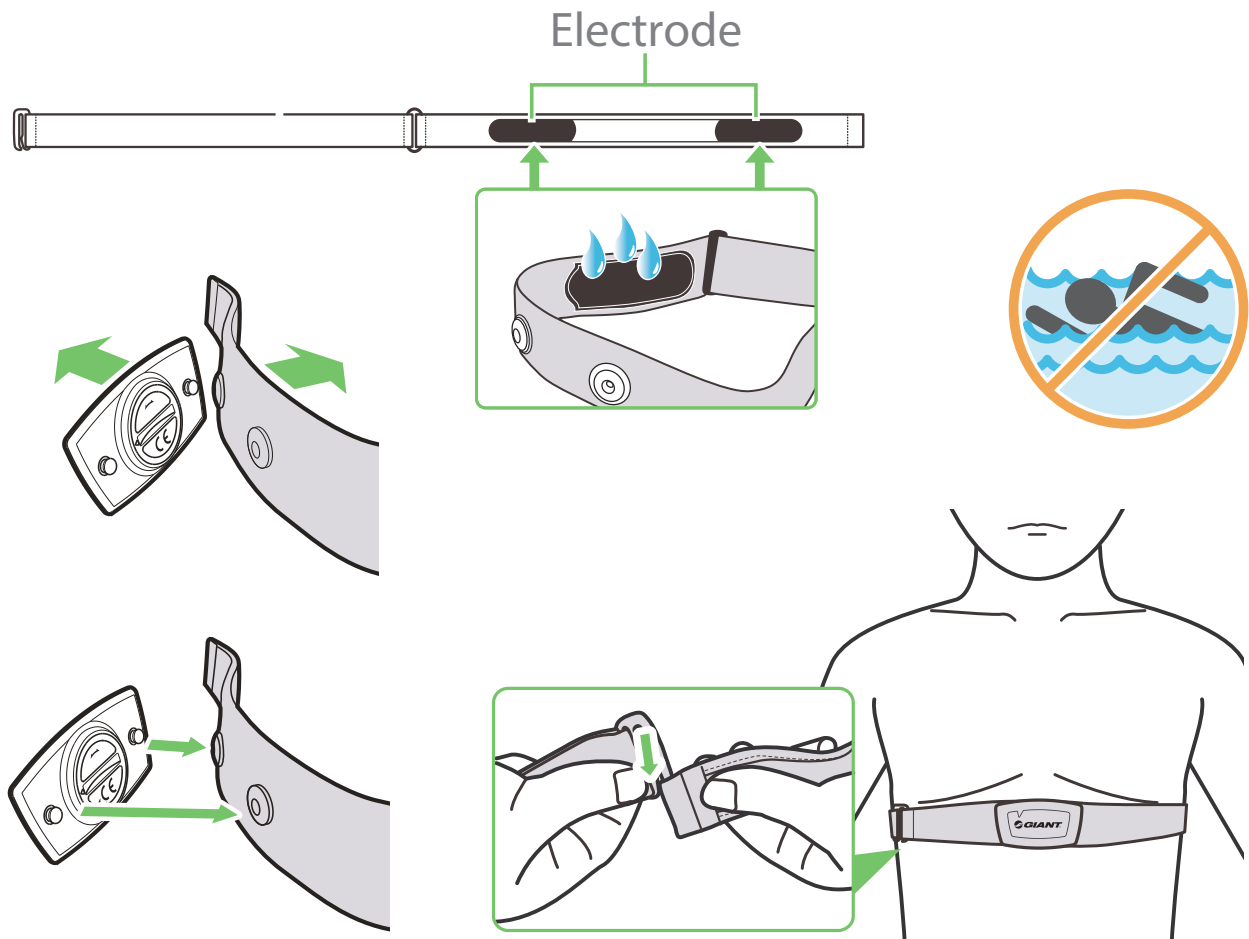

Note:

- Please wear appropriate clothing to keep the heart rate belt in the required temperature.
- DO NOT wear your heart rate monitor over clothing; wear it directly on your body instead.
- Position the sensor in the middle of your body (wear it below the chest). Point the Giant logo shown on the sensor upward; secure the elastic band to prevent it from falling off during exercise.
- If the sensor fails to detect temperature or the reading looks abnormal, please warm it up for about 5 minutes.
- Detach the sensor from the heart rate belt and keep them isolated from each other if you are not to use them for an extended period of time.
- When the battery of the heart rate monitor belt is low on charge, the heart rate value on the information page will flash.

Caution: Improper battery replacement may lead to explosion. Please replace the battery with a new one from device manufacturer or similar types set by it. Please dispose of waste batteries in accordance with local regulations.



Please collect your waste batteries separated from other household garbage for easy recycling and special treatment to protect our environment.

Wheel Diameter and Circumference

The wheel diameter is indicated on both sides of the tire.

Wheel Diameter	Length (mm)
12x1.75	935
12x1.95	940
14x1.50	1020
14x1.75	1055
16x1.50	1185
16x1.75	1195
16x2.00	1245
16x1-1/8	1290
16x1-3/8	1300
17x1-1/4	1340
18x1.50	1340
18x1.75	1350
20x1.25	1450
20x1.35	1460
20x1.50	1490
20x1.75	1515
20x1.95	1565
20x1-1/8	1545
20x1-3/8	1615
22x1-3/8	1770
22x1-1/2	1785
24x1.75	1890
24x2.00	1925
24x2.125	1965
24x1(520)	1753
24x3/4 Tubular	1785
24x1-1/8	1795
24x1-1/4	1905
26x1(559)	1913
26x1.25	1950
26x1.40	2005
26x1.50	2010
26x1.75	2023
26x1.95	2050
26x2.10	2068
26x2.125	2070
26x2.35	2083

Wheel Diameter	Length (mm)
26x3.00	2170
26x1-1/8	1970
26x1-3/8	2068
26x1-1/2	2100
650C Tubular 26x7/8	1920
650x20C	1938
650x23C	1944
650x25C 26x1(571)	1952
650x38A	2125
650x38B	2105
27x1(630)	2145
27x1-1/8	2155
27x1-1/4	2161
27x1-3/8	2169
27.5x1.50	2079
27.5x2.1	2148
27.5x2.25	2182
700x18C	2070
700x19C	2080
700x20C	2086
700x23C	2096
700x25C	2105
700x28C	2136
700x30C	2146
700x32C	2155
700C Tubular	2130
700x35C	2168
700x38C	2180
700x40C	2200
700x42C	2224
700x44C	2235
700x45C	2242
700x47C	2268
29x2.1	2288
29x2.2	2298
29x2.3	2326

NeosGPS Basic Maintenance

Good maintenance can reduce the risk of damage.

- DO NOT drop this device or subject it to heavy impacts.
- DO NOT expose this device to extreme cold/hot or high humidity environments.
- The screen surface is prone to being scratched. Please use a non-adhesive general purpose screen protector to protect it from minor scratches.
- Clean this device with a soft cloth wetted with a diluted neutral detergent.
- DO NOT disassemble, repair, or modify this device or the product warranty may be voided.

Digital Information

Some data will display only after being paired with a Bluetooth sensor and connected to the device.

Time: Current GPS satellite time.

Ride Time: Time elapsed since the beginning of this ride.

Trip Time: Total time spent on current trip (stops included).

Distance: Distance traveled over current ride.

Odometer: Before resetting the odometer, it is the total distance ridden by this stopwatch.

Current Speed: Distance biked up to now divided by time.

Average Speed: Average riding speed now.

Maximum Speed: Maximum speed of current ride.

Cadence: Number of pedals per minute now.

A compatible Bluetooth cadence sensor is required to be connected to your device.

Average Cadence: Average pedaling frequency now.

Maximum Cadence: Maximum pedaling frequency of the current ride.

Heart Rate: Heart rate per minute now.

A compatible Bluetooth heart rate sensor is required to be connected to your device.

Average Heart Rate: Average heartbeat rate now

Maximum Heart Rate: The maximum heartbeat rate during the current ride.

Lactate Threshold Heart Rate: The average heart rate when lactic acid starts to accumulate and cannot be metabolized during vigorous training.

Lactate Threshold Heart Rate: Percentage of current heartbeat rate over lactate threshold value.

Lactate Threshold Heart Rate Range: Heart rate range of current lactate threshold value.

限用物質含有情況標示聲明書

Declaration of the Presence Condition of the Restricted Substances Marking

設備名稱：GPS Bike Recorder, 型號（型式）：NeosGPS Equipment name Type designation (Type)						
單元 Unit	限用物質及其化學符號 Restricted substances and its chemical symbols					
	鉛 Lead (Pb)	汞 Mercury (Hg)	鎘 Cadmium (Cd)	六價鉻 Hexavalent chromium (Cr+6)	多溴聯苯 Polybrominated biphenyls (PBB)	多溴二苯醚 Polybrominated diphenyl ethers (PBDE)
外殼 Enclosure	○	○	○	○	○	○
電路板 PCB	○	○	○	○	○	○
螢幕 Screen	○	○	○	○	○	○
連接線 Connection Line	○	○	○	○	○	○
<p>備考1. “超出0.1 wt %” 及 “超出0.01 wt %” 係指限用物質之百分比含量超出百分比含量基準值。 Note 1: “Exceeding 0.1 wt %” and “exceeding 0.01 wt %” indicate that the percentage content of the restricted substance exceeds the reference percentage value of presence condition.</p> <p>備考2. “○” 係指該項限用物質之百分比含量未超出百分比含量基準值。 Note 2: “○” indicates that the percentage content of the restricted substance does not exceed the percentage of reference value of presence.</p> <p>備考3. “-” 係指該項限用物質為排除項目。 Note 3: The “-” indicates that the restricted substance corresponds to the exemption.</p>						

Product Certification Number:

CCAJ18LP1870TO

CI537069050042—00

FCC ID : ZL7-NEOSGPS

IC : 9707A-NEOSGPS

Product specifications and functions in this Manual are for reference only.
This Company may change them without further notice.